

# **TECHNICAL NOTES**

Sound Level Meter

**NL-22 / NL-32**



3-20-41 Higashimotomachi, Kokubunji, Tokyo 185-8533, Japan

<http://www.rion.co.jp/english/>



# Organization of the NL-22/NL-32 Documentation

The documentation for the Sound Level Meter NL-22 and NL-32 consists of three separate manuals.

- **Instruction Manual**

Describes operating procedures for the Sound Level Meter NL-22 and NL-32, connection and use of peripheral equipment such as a level recorder and printer, and use of the memory card.
  - **Serial Interface Manual**

Describes how to use the serial interface built into the Sound Level Meter NL-22 and NL-32. The manual covers the communication protocol, use of control commands for the sound level meter, format of data output by the sound level meter, and other topics.
  - **Technical Notes (this document)**

This document provides in-depth information about the performance of the sound level meter, microphone construction and characteristics, influence of extension cables and windscreen on the measurement, and other topics.
- \* Company names and product names mentioned in this manual are usually trademarks or registered trademarks of their respective owners.

# Contents

Organization of the NL-22/NL-32 Documentation .....	i
Microphone .....	1
Construction and Operation Principle .....	1
Frequency Response .....	2
Directional Characteristics .....	3
Thermal Characteristics .....	4
Humidity Characteristics .....	5
Microphone Specifications .....	6
Preamplifier .....	7
Preamplifier Requirement .....	7
Preamplifier Specifications .....	7
Influence of Microphone Extension Cable .....	8
Frequency Weighting Network .....	9
RMS Detection Circuit and Time Weighting .....	10
Measurement Functions .....	13
$L_{Aeq}$ (time average sound level, equivalent continuous sound level) .....	13
$L_{AE}$ (sound exposure level) .....	14
$L_N$ (percentile sound level) .....	15
$L_{max}, L_{min}$ (maximum and minimum time-weighted sound level) .....	15
$L_{Atm5}$ (Takt-max sound level) .....	16
$L_{peak}$ (peak sound level) .....	16
Influence of Background Noise .....	17
Reduction of Wind Noise by Windscreen .....	18
Influence of Body reflection .....	20
Influence of Operator .....	21
I/O Connector .....	22

# Microphone

Measurements of sound pressure level can be carried out with a variety of microphone types. The sound level meter NL-22 employs the prepolarized condenser microphone UC-52 (NL-32 employs UC-53A) that is compact and delivers stable and reliable response.

## Construction and Operation Principle

As shown in the drawing below, an electret condenser microphone consists of four main parts: diaphragm, backplate, insulator, and housing. The surface of the backplate is covered by a film holding an electrical charge. When sound pressure is applied to the diaphragm, the distance between the diaphragm and the backplate changes, thereby altering the capacitance. Using a load resistor, this change can be turned into a voltage change. The frequency response as well as the temperature and humidity characteristics of an prepolarized condenser microphone depend considerably on the type and properties of the materials used. The frequency range is determined by the resonance frequency of the diaphragm assembly.

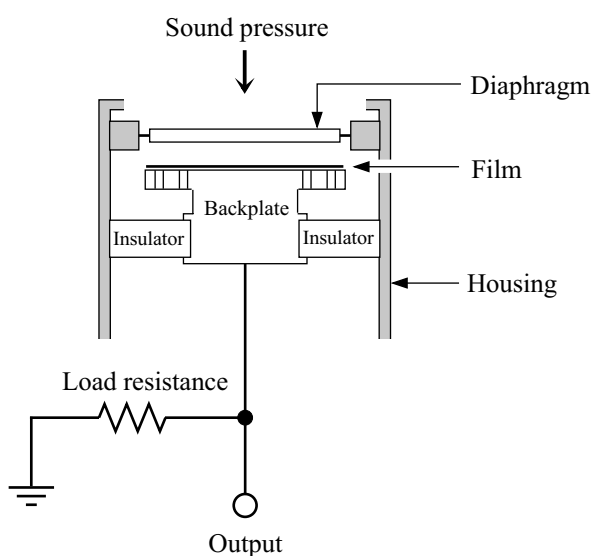

Construction of prepolarized condenser microphone

## Frequency Response

The frequency response of a sound field microphone is expressed as the frequency response in the reference direction of incidence ( $0^\circ$ ). The diagram below shows an example for the frequency response of the microphone UC-52.

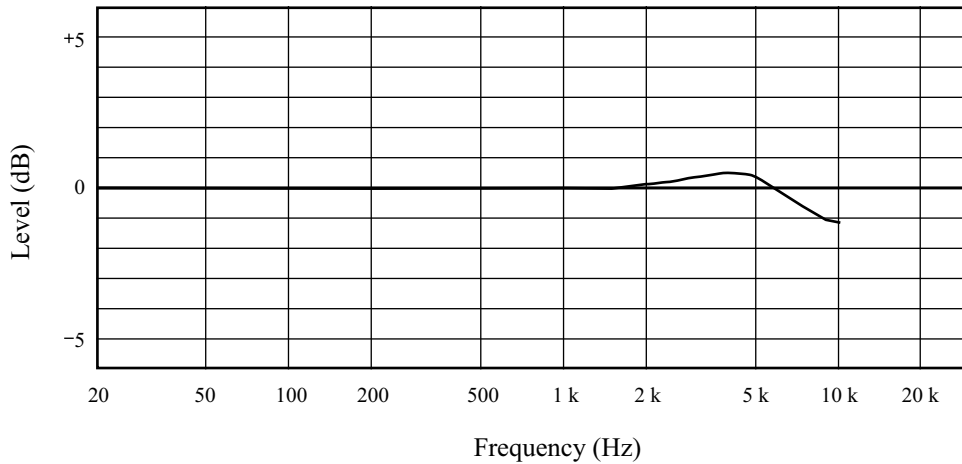

Frequency response sample of microphone UC-52

The diagram below shows an example for frequency response of the microphone UC-53A.

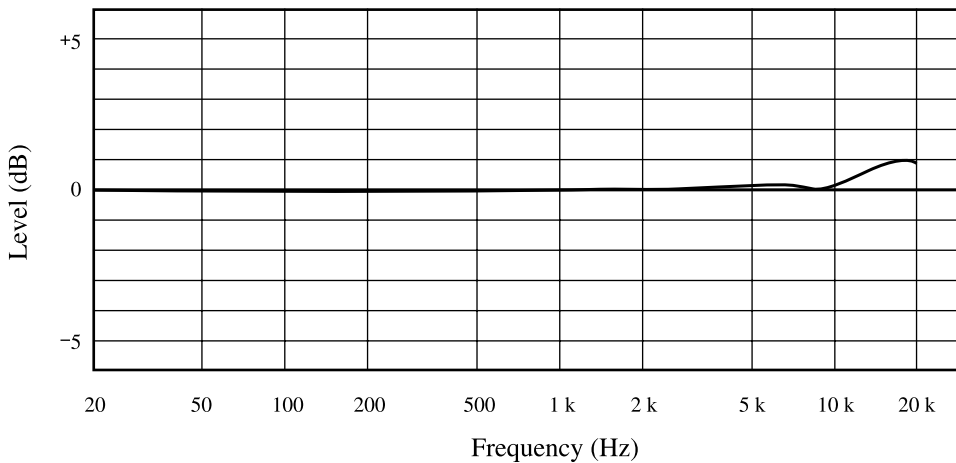

Frequency response sample of microphone UC-53A

## Directional Characteristics

The directional characteristics of a microphone is a measure of its differing sensitivity for sound waves arriving from various angles. Since the prepolarized condenser microphone used in the NL-22 / NL-32 is a pressure-sensitive type, it should be equal sensitive in all directions. However, refraction and cavity effects cause a certain microphone directional response at high frequencies. The diagram below shows the directional response of the microphone UC-52.

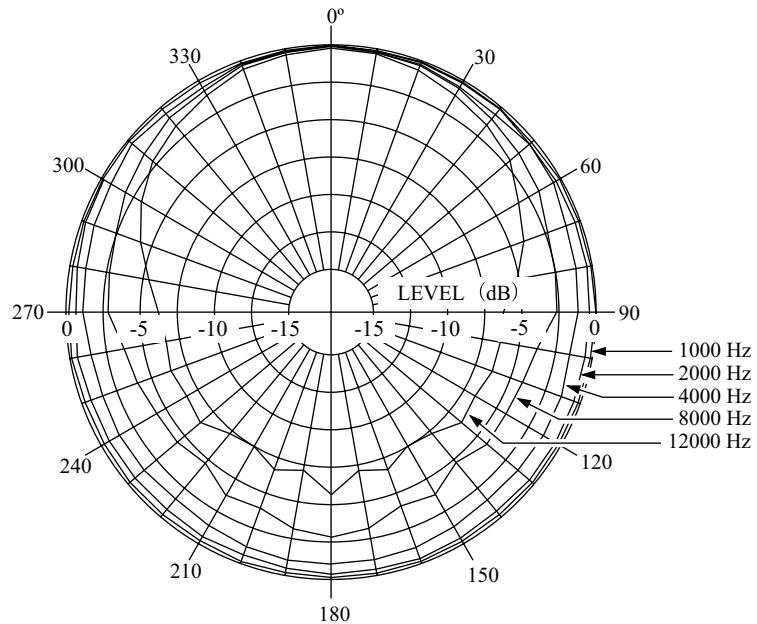

The diagram below shows the directional response of the microphone UC-53A.

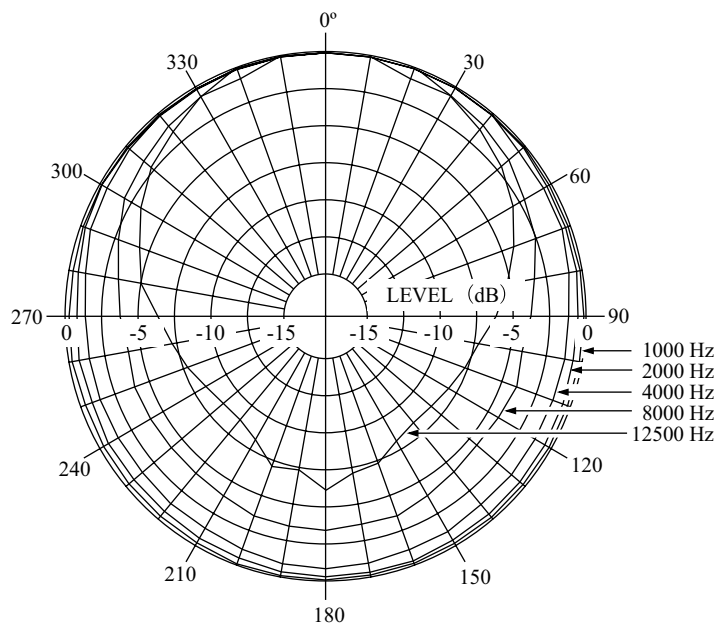

## Thermal Characteristics

The thermal characteristics of a microphone indicate how sensitivity changes at various temperatures. This is influenced by the choice of materials and the design of the microphone. Normally, materials with a linear expansion coefficient are used. The diagrams below show the thermal characteristics of the microphone UC-52.

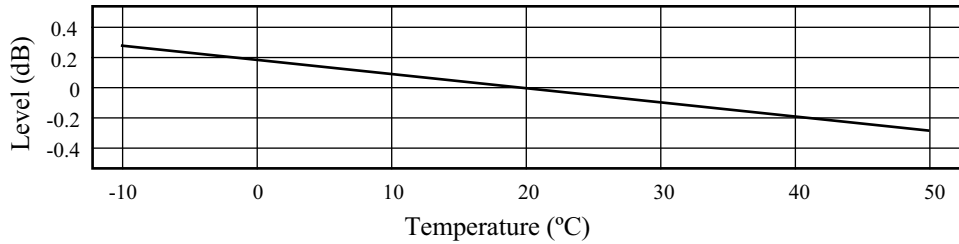

Thermal characteristics (at 250 Hz)

The diagrams below show the thermal characteristics of the microphone UC-53A.

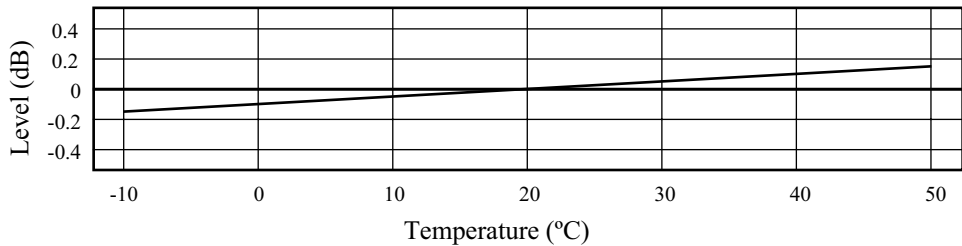

Thermal characteristics (at 250 Hz)



## Humidity Characteristics

The humidity characteristics of a microphone indicate how sensitivity changes at various humidity levels. The diagrams below show the microphone UC-52.

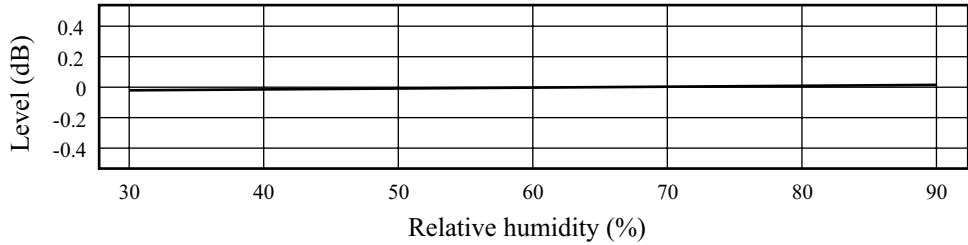

Humidity characteristics (at 250 Hz)

The diagrams below show the microphone UC-53A.

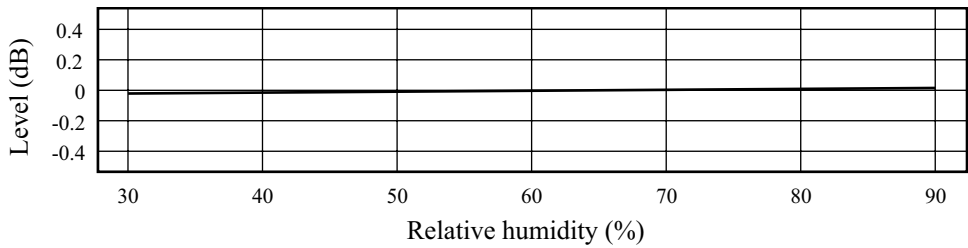

Humidity characteristics (at 250 Hz)

## Microphone Specifications

Model:	UC-52
Nominal diameter:	1 / 2 inch
Sensitivity:	-33 dB (0 dB = 1 V / Pa)
Frequency response:	20 to 8000 Hz
Capacitance:	19 pF
Diaphragm type:	Titan alloy film
Temperature coefficient:	-0.008 dB / (at 250 Hz)
Humidity-dependent sensitivity change:	0.1 dB or less (at 250 Hz, RH below 95%, no condensation)
Dimensions:	13.2 dia. × 12 mm

Model:	UC-53A
Nominal diameter:	1 / 2 inch
Sensitivity:	-28 dB (0 dB = 1 V / Pa)
Frequency response:	10 to 20000 Hz
Capacitance:	12 pF
Diaphragm type:	Titan alloy film
Temperature coefficient:	+0.005 dB / (at 250 Hz)
Humidity-dependent sensitivity change:	0.1 dB or less (at 250 Hz, RH below 95%, no condensation)
Dimensions:	13.2 dia. × 12.9 mm

# Preamplifier

## Preamplifier Requirement

Since the condenser microphone is a small-capacity transducer, it has high impedance, especially at low frequencies. Therefore a very high load resistance is required to ensure uniform response extending to the low frequency range. The relationship between the microphone capacitance and the low-range cutoff frequency can be expressed as follows.

$$f_0 = \frac{1}{2\pi \cdot Z_{in} \cdot C_m}$$

$f_0$ : Low-range cutoff frequency (Hz)

$Z_{in}$ : Preamplifier input impedance ( $\Omega$ )

$C_m$ : Capacitance of condenser microphone (F)

If the output of the microphone were directly routed through a long shielded cable, the capacitance between the cable conductors would cause a sharp drop in sensitivity, as is evident from the following equation.

$$M_0 = \frac{C_m}{C_m + C_c} \cdot M_s$$

$M_0$ : Output voltage into directly connected shielded cable (V)

$M_s$ : Output voltage in microphone open condition (V)

$C_c$ : Cable capacitance of shielded cable (F)

For the above reasons, a preamplifier is connected directly after the microphone, to provide a low-impedance output signal.

## Preamplifier Specifications

Model name:	NH-21
Input impedance:	3 G $\Omega$
Output impedance:	Less than 300 $\Omega$
Maximum output current:	2 mA

# Influence of Microphone Extension Cable

When the output of the microphone/preamplifier is routed through an extension cable, certain limitations regarding measurable sound pressure level and frequency range will apply. This is due to the influence of the cable capacitance. The longer the cable, the lower the measurable sound pressure level and the lower the frequency limit. The diagram below shows the relationship among cable length, measurable sound pressure level, and frequency.

Extension cable EC-04 series

Model	Length	Model	Length
EC-04	2 m	EC-04C	30 m (reel) + 5 m (connection cable)
EC-04A	5 m	EC-04D	50 m (reel) + 5 m (connection cable)
EC-04B	10 m	EC-04E	100 m (reel) + 5 m (connection cable)

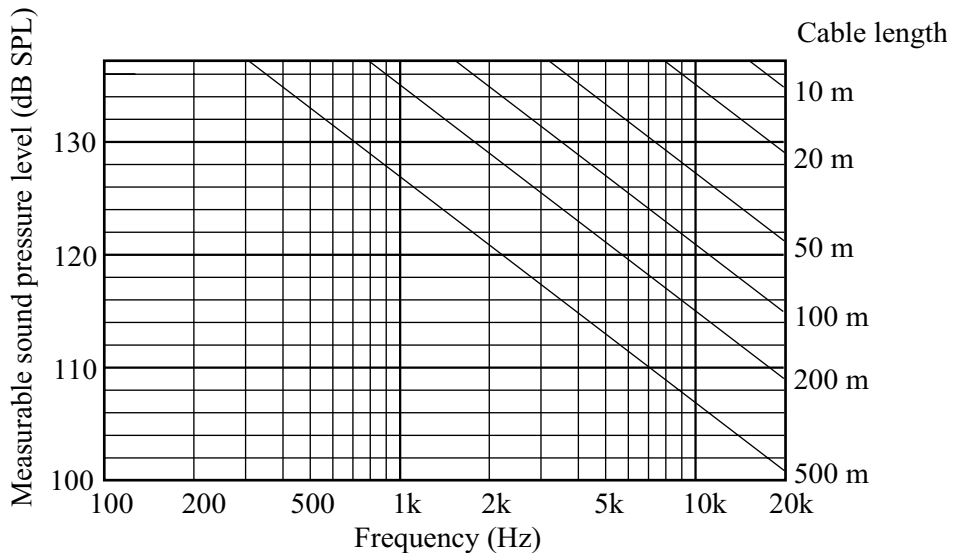

If for example a sound pressure level of 123 dB is to be measured up to 8 kHz, an extension cable length of up to 100 meters can be used.

# Frequency Weighting Network

The NL-22 / NL-32 provides frequency weightings A, C and FLAT. The electrical characteristics of the weighting network at AC output connector are as shown below.

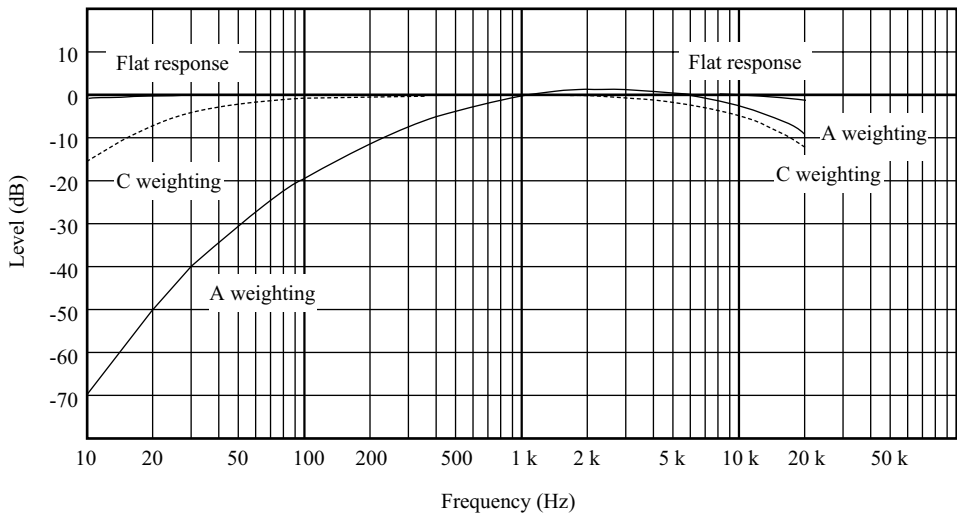

Frequency weighting characteristics

The volume impression (loudness) of a sound depends not only on the sound pressure level, but also on the frequency. At high or low frequencies, a sound is felt to be less loud than a sound of equal level in the midrange. The frequency weighting A compensates for this effect and produces measurement results which are close to the actual impression of loudness. For this reason, this type of frequency weighting is widely used for purposes such as sound level evaluation.

With the frequency weighting FLAT, frequency response is linear, which is suitable for sound pressure level measurements and for using the sound level meter output for frequency analysis.

The frequency weighting C curve produces almost flat response, but with a roll off below 31.5 Hz and above 8 kHz. This is suitable for sound pressure level measurements in situations with unwanted low-frequency or high-frequency components.

# RMS Detection Circuit and Time Weighting

The sound level meter uses rms detection. The effective value  $E$  (rms) is defined by the following equation.

$$E(\text{rms}) = \sqrt{\frac{1}{T} \int_0^T e^2 dt}$$

The voltage  $e$  which changes over time is raised to the power of 2, and integration for the time interval  $T$  is performed. The result is divided by  $T$  and the square root is extracted. The circuit configuration for performing the above mathematical operation looks as follows.

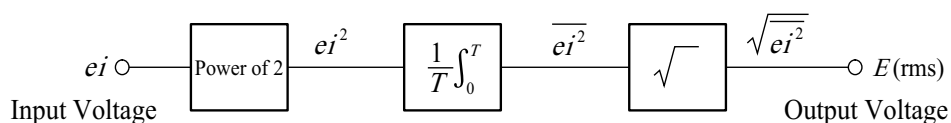

The NL-22/NL-32 uses digital processing to determine the rms value.

During sound level measurements, the level often fluctuates drastically, which would make it difficult to evaluate readings if some kind of averaging is not applied. Sound level meters therefore provide the capability for index weighting (index averaging) using the rms circuit. The parameters of this weighting process are called the time weightings, determined by the time constant (see next page).

Sound level meters usually have a F(Fast) and S(Slow) setting for the time weighting. The time range that is considered for averaging is narrow in the F(Fast) setting and wide in the S(Slow) setting. In the F(Fast) setting, the instantaneous level has a larger bearing on the displayed value than in the S(Slow) setting. From the point of view of the measurement objective, the F(Fast) setting is more suitable to situations with swiftly changing sound level, whereas the S(Slow) setting yields a more broadly averaged picture.

The F(Fast) setting is more commonly used, and sound pressure level values given without other indication are usually made with F(Fast) characteristics.

The S(Slow) time weighting setting is suitable for measuring the average of sound with fairly constant levels. For example, in Japan aircraft noise and high-speed train noise is usually transient noise with high fluctuation, but the S(Slow) setting is used to determine the maximum level for each noise event.

The I(Impulse) setting enables the meter to track noise bursts of very short duration.

### Time weightings and time constant

Time weightings	Time constant	
	Rise time	Decay time
F(Fast)	125 ms	125 ms
S(Slow)	1 s	1 s
I(Impulse)	35 ms	1.5 s

The time weighting network of the sound level meter performs index averaging on the square of the sound pressure signal. The equivalent circuit is shown at right.  $\tau$  is the time constant, which equals  $CR$ .

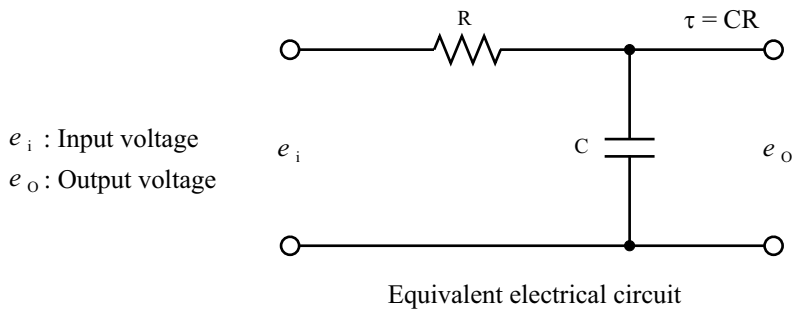

The response of the index averaging circuit to a single burst signal is shown below.

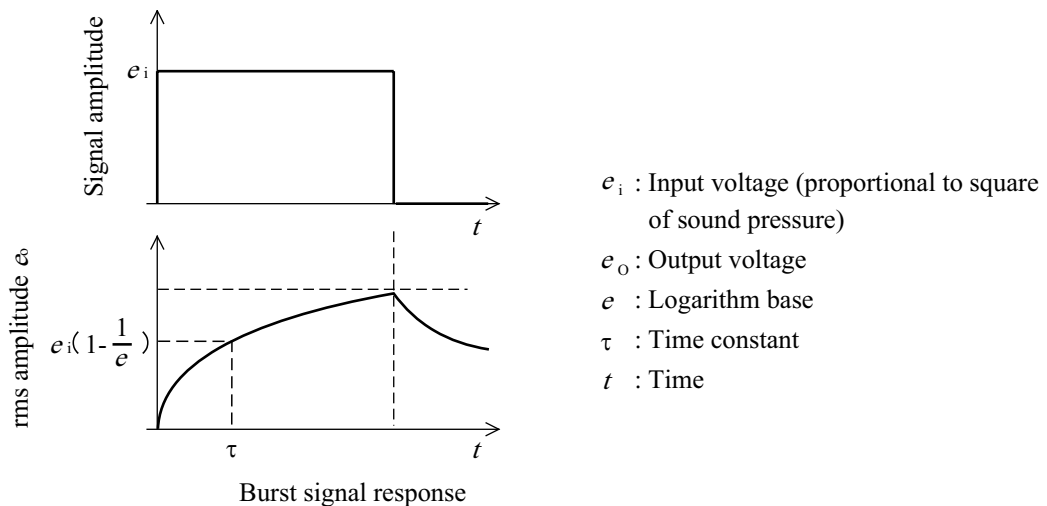



# Measurement Functions

## $L_{Aeq}$ (Time average sound level, equivalent continuous sound level)

For a sound pressure level signal that changes over time, the  $L_{Aeq}$  (equivalent continuous sound level) is a hypothetical constant sound pressure level that has the same energy as the actually measured signal in the measurement interval. It is determined by the following equation.

$$L_{AeqT} = 20 \log_{10} \left\{ \left[ (1/T) \int_{t_1}^{t_2} P_A^2(t) dt \right]^{1/2} / P_0 \right\}$$

- $t$ : Time variable of integration from an arbitrary start time at  $t_1$  to the end of the interval at  $t_2$   
 $T$ : Time interval  $T = t_2 - t_1$   
 $P_A(t)$ : A-weighted instantaneous sound pressure at running time  $t$   
 $P_0$ : Reference sound pressure (20  $\mu$ Pa)

In sound pressure level meter NL-22/NL-32, the digital processing to determine  $L_{Aeq}$  is carried out according to the following equation.

$$L_{Aeq} = 20 \log_{10} \left\{ \left( \frac{1}{N} \sum_{i=1}^N P_A^2(i) \right)^{1/2} / P_0 \right\}$$

N: Number of samples

In NL-22/NL-32, the sampling interval for A/D conversion is 20.8  $\mu$ s (48000 samples per second).

## $L_{AE}$ (sound exposure level)

The  $L_{AE}$  (sound exposure level) is a hypothetical constant 1-second sound pressure level having the same energy as a single-event sound pressure level measured with A weighting. It is determined by the following equation.

$$L_{AE} = 10 \log_{10} \left\{ \left[ \int_{t_1}^{t_2} P_A^2(t) dt \right] / P_0^2 T_0 \right\} = L_{Aeq} + 10 \log_{10}(T/T_0)$$

$t$ : Time variable of integration from an arbitrary start time at  $t_1$  to the end of the interval at  $t_2$

$T$ : Time interval  $T = t_2 - t_1$

$T_0$ : Reference time (1 second)

$P_A(t)$ : A-weighted instantaneous sound pressure at running time  $t$

$P_0$ : Reference sound pressure (20  $\mu$ Pa)

In NL-22/NL-32, the digital processing is carried out according to the following equation.

$$L_{AE} = 10 \log_{10} \frac{1}{N_0} \sum_{i=1}^N \frac{P_A^2(i)}{P_0^2}$$

$N_0$ : Number of samples per second

In NL-22/NL-32, the sampling interval for A/D conversion is 20.8  $\mu$ s (48000 samples per second).

## **$L_N$ (percentile sound level)**

The  $L_N$  (percentile sound level) is the sound level which was exceeded for  $N$  percent of the measurement time. The NL-22/NL-32 allows the user to select five values for  $N$  (from 1 to 99, in 1 steps). The sampling interval for  $L_N$  processing is 100 ms (10 samples per second).

## **$L_{\max}$ , $L_{\min}$ (maximum and minimum time-weighted sound level)**

$L_{\max}$  is the maximum time-weighted sound level and  $L_{\min}$  the minimum time-weighted sound level encountered during a measurement.

In NL-22/NL-32, the sampling interval for A/D conversion is 20.8  $\mu\text{s}$  (48000 samples per second). The maximum and minimum values since the start of the measurement are stored. Therefore the  $L_{\max}$  and  $L_{\min}$  readings up to the current point can be displayed already during measurement.

## **$L_{\text{Atm5}}$ (Takt-max sound level) \***

For the duration of the measurement, the maximum level within a 5-second interval is sampled and the power average is determined.  $L_{\text{Atm}}$  is calculated according to the following equation.

$$L_{\text{tm}} = 10 \log_{10} \frac{1}{N} \sum_{i=1}^N 10^{L_m/10}$$

$L_m$ : Maximum level within interval (5 seconds)

$N$ : Number of samples

The number of samples is determined according to the following equation.

For  $L_{\text{tm5}}$ : 
$$N = \frac{(t_2 - t_1)}{5}$$

$t_1$ : Measurement start time

$t_2$ : Measurement end time

\*  $L_{\text{tm}}$  is specified by DIN as "Taktmaximalpegel Mittelwert", and its meaning in English is "Power averaged maximum sound level in a measuring period".

## **$L_{\text{peak}}$ (peak sound level)**

The peak sound level is twenty times the logarithm to the base ten of the ratio of a peak sound pressure to the reference sound pressure, peak sound pressure being obtained with a standard frequency weighting.

# Influence of Background Noise

When measuring a certain sound in a certain location, all other sounds present at that location except the measurement target sound are background noise (also called ambient noise or dark noise). Since the sound level meter will display the combination of target sound and background noise, the amount of background noise must be taken into consideration when determining the level of the target sound.

If the difference between the meter reading in absence of the target sound and the reading with the target sound is more than 10 dB, the influence of background noise is small and may be disregarded. If the difference is less than 10 dB, the values shown in the table below may be used for compensation, to estimate the level of the target sound.

Background noise compensation

Display reading difference with and without target sound (dB)	4	5	6	7	8	9
Compensation value (dB)	-2	-1				

If for example the measured sound level when operating a machine is 70 dB, and the background noise level when the machine is not operating is 63 dB, the compensation value for the difference of 7 dB is -1 dB. Therefore the sound level of the machine can be taken to be  $70 \text{ dB} + (-1 \text{ dB}) = 69 \text{ dB}$ .

The above principle for compensating the influence of the background noise assumes that both the background noise and the target sound are approximately constant. If the background noise fluctuates, and especially if it is close in level to the target sound, compensation is difficult and will often be meaningless.

# Reduction of Wind Noise by Windscreen

During outdoor measurements or measurement of ventilation devices, wind noise can falsify measurement results. To counter such problems, the supplied windscreen WS-10 should be mounted on the microphone. The characteristics of the WS-10 are shown below. The attenuation of wind noise produced by the windscreen is about 25 dB with frequency weighting A and 15 dB with frequency weighting C.

The influence of the windscreen WS-10 on the acoustic performance of the microphone is within  $\pm 1.0$  dB up to 12.5 kHz, as shown in the diagram on the next page.

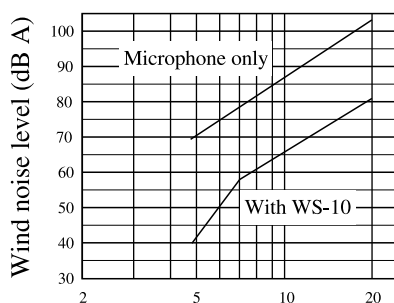

Wind velocity (m/s)  
Frequency weighting A

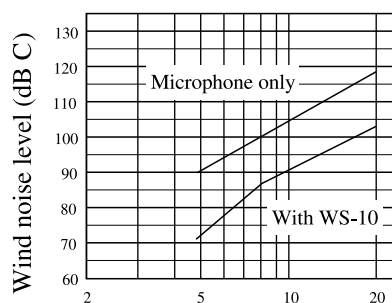

Wind velocity (m/s)  
Frequency weighting C

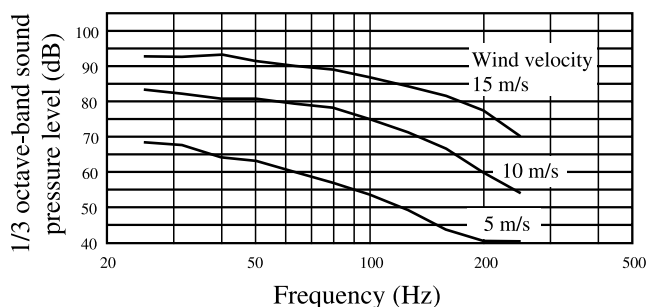

Frequency response of wind noise measured with windscreen WS-10 mounted on microphone

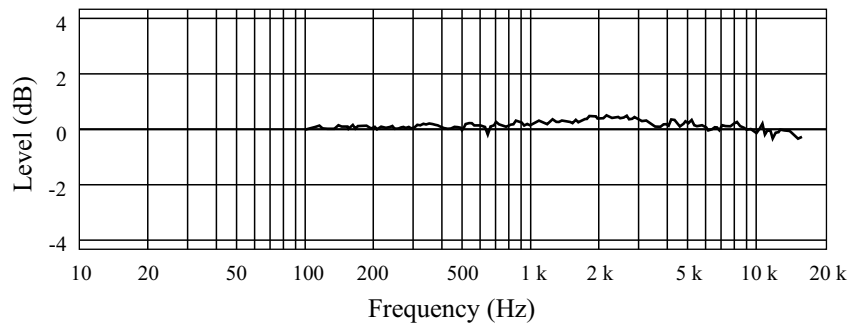

Influence of windscreen WS-10 on acoustical properties of microphone (referred to microphone response without windscreen)

# Influence of Body reflection

The NL-22/NL-32 is designed to minimize reflections caused by the body of the unit.

The charts below show the influence on the measurement.

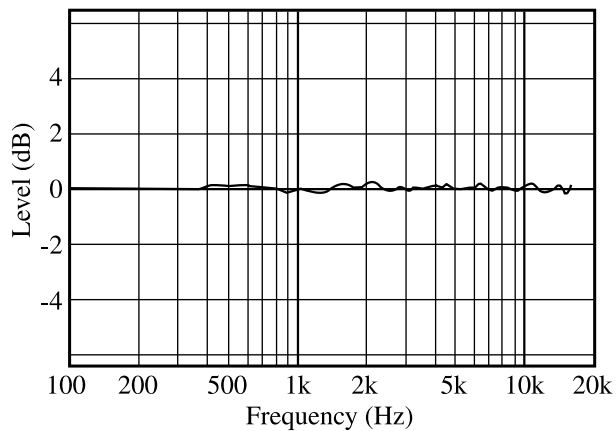

Body reflection



# Influence of Operator

The NL-22 / NL-32 is designed to minimize reflections caused by the body of the unit. The charts below show the influence of the operator on the measurement.

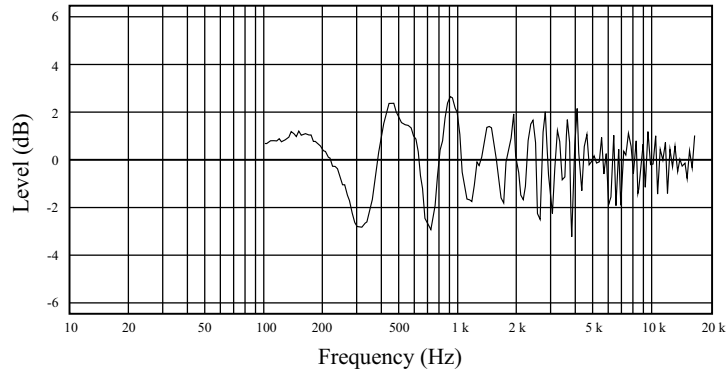

Acoustical influence of sound level meter body (the distance from the top of the microphone to the operator is approx. 40 cm)

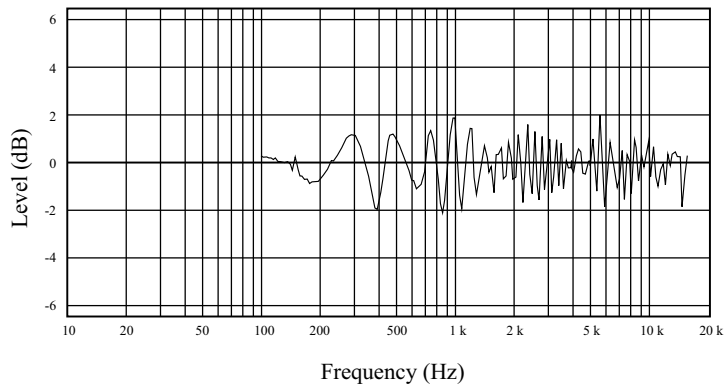

Acoustical influence of sound level meter body (the distance from the top of the microphone to the operator is approx. 70 cm)

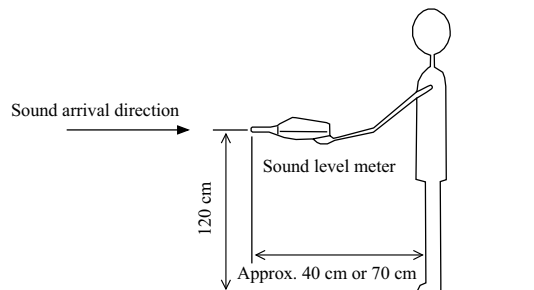

Measurement conditions for acoustical influence of operator

# I/O Connector

The I/O connector on the NL-22 / NL-32 serves for input of control signals and input/output of data. It has the following functions.

- Measurement data output to printer CP-10, CP-11, DPU-414  
(with printer cable CC-93)
- Communication with a computer (serial interface)  
(with interface cable CC-92)
- Comparator output  
(with comparator cable CC-94)



